

TC-920(B)

SERVICE MANUAL

FRONT PANEL

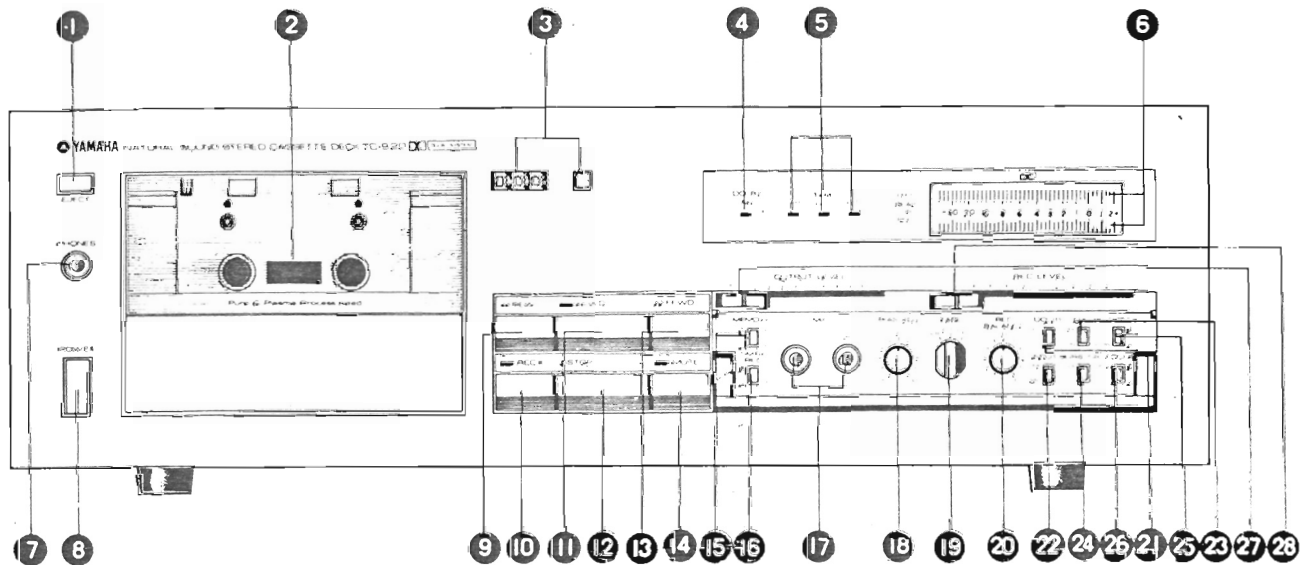

- | | | | |
|-----------------------------|------------------------------------|---|---|
| ① EJECT BUTTON | ⑩ REC BUTTON ■ (RECORDING STANDBY) | ⑮ BIAS ADJ. KNOB | ⑳ REC BALANCE CONTROL
(RECORDING BALANCE ADJ.) |
| ② CASSETTE COMPARTMENT | ⑪ FWD BUTTON ► (PLAY) | ⑯ TAPE (TAPE SELECTOR) SWITCH | ㉑ DOLBY NR BUTTON |
| ③ TAPE COUNTER/RESET BUTTON | ⑫ STOP BUTTON ■ | ⑰ MIC JACKS | ㉒ INPUT (INPUT SELECTOR) BUTTON |
| ④ DOLBY NR INDICATOR | ⑬ F-FWD BUTTON ►► | ⑱ BIAS ADJ. KNOB | ㉓ MPX FILTER BUTTON |
| ⑤ TAPE INDICATOR | ⑭ MUTE (RECORDING MUTE) BUTTON | ⑲ TAPE (TAPE SELECTOR) SWITCH | ㉔ SUBSONIC (SUBSONIC FILTER) BUTTON |
| ⑥ PEAK LEVEL METER | ⑮ MEMORY STOP SWITCH | ⑳ REC BALANCE CONTROL
(RECORDING BALANCE ADJ.) | ㉕ METER (METER RECOVERY TIME) BUTTON |
| ⑦ PHONES JACK | | ㉑ DOLBY NR BUTTON | ㉖ FOCUS BUTTON |
| ⑧ POWER SWITCH | | ㉒ INPUT (INPUT SELECTOR) BUTTON | ㉗ OUTPUT LEVEL CONTROL |
| ⑨ REW BUTTON ◀◀ | | ㉓ MPX FILTER BUTTON | ㉘ REC LEVEL CONTROL |
| | | ㉔ SUBSONIC (SUBSONIC FILTER) BUTTON | |
| | | ㉕ METER (METER RECOVERY TIME) BUTTON | |
| | | ㉖ FOCUS BUTTON | |
| | | ㉗ OUTPUT LEVEL CONTROL | |
| | | ㉘ REC LEVEL CONTROL | |

■ CONTENTS

PACKAGE INSTRUCTION	2
INTERNAL VIEW	3
DISASSEMBLY PROCEDURE	4
ADJUSTMENTS	6
SPECIFICATIONS	8
BLOCK DIAGRAM	8
WIRING	9
SCHEMATIC DIAGRAM	10

■ PACKAGE

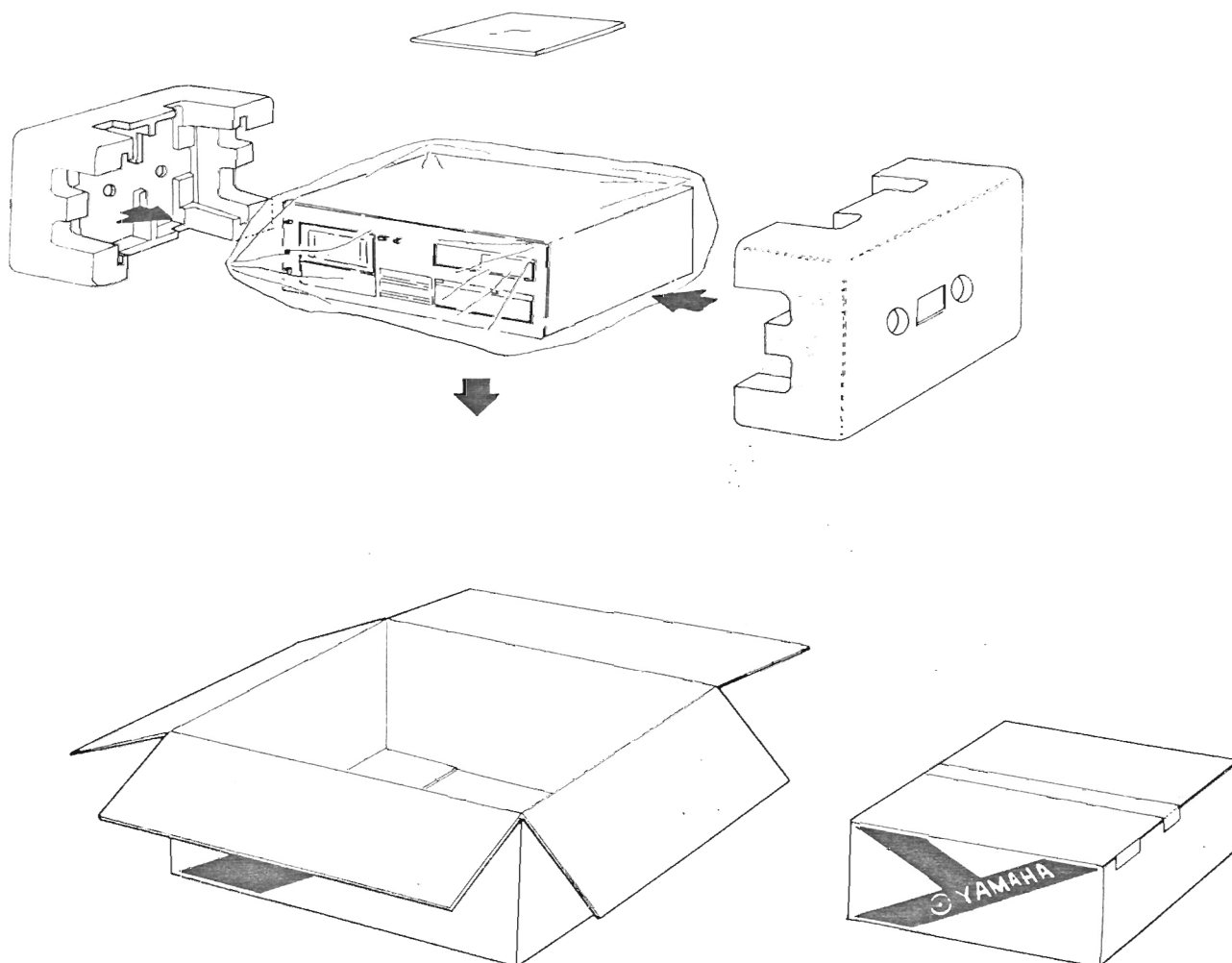

INTERNAL VIEW

TOP VIEW

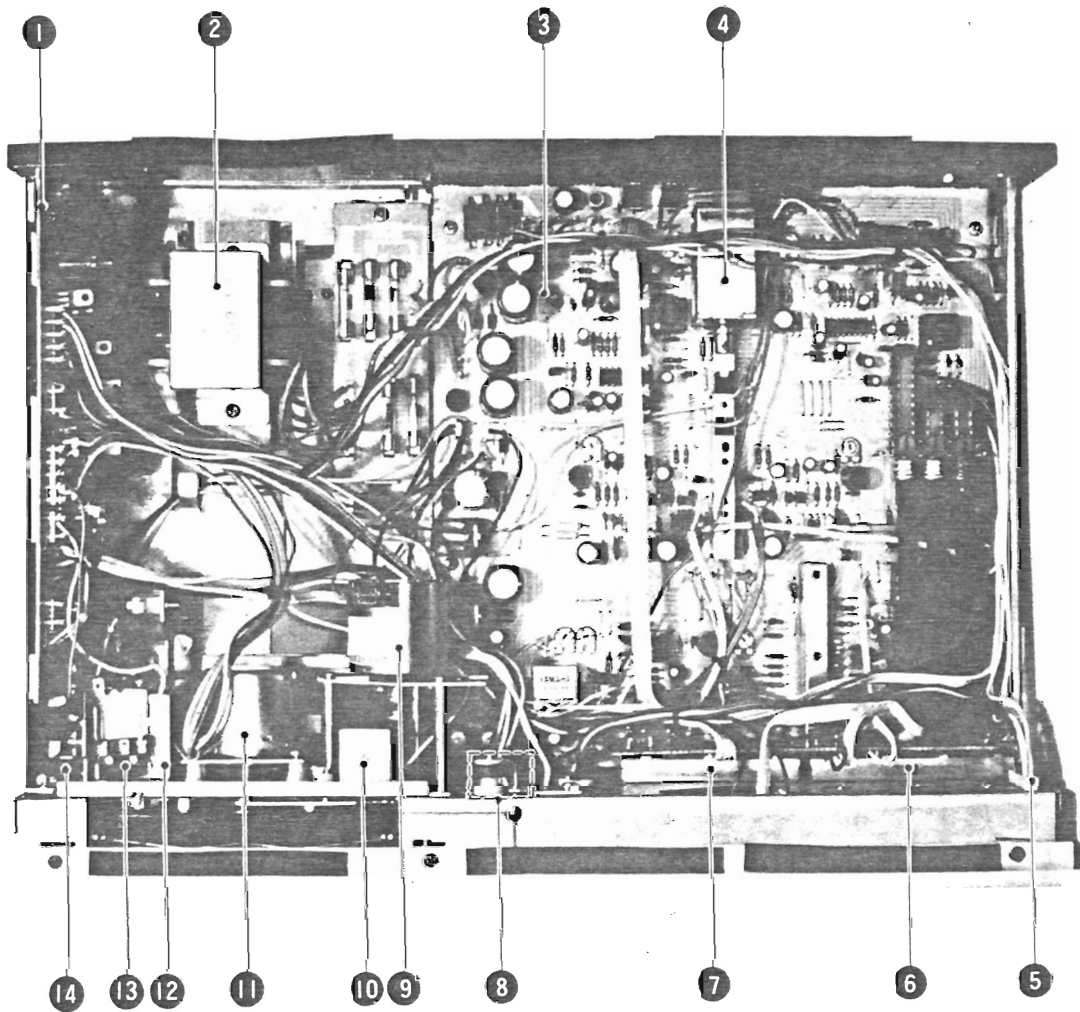

- ① CONTROL PRINTED CIRCUIT BOARD (NA07210)
- ② POWER TRANSFORMER
- ③ RECORDING AND PLAYBACK PRINTED CIRCUIT BOARD
- ④ REC/PB SOLENOID
- ⑤ CONNECTOR (LEVEL METER)
- ⑥ REC LEVEL VR

- ⑦ OUTPUT LEVEL VR
- ⑧ HALL IC
- ⑨ CAPSTAN MOTOR
- ⑩ BRAKE SOLENOID
- ⑪ REEL MOTOR
- ⑫ HEAD SOLENOID
- ⑬ MISERASING PROTECT SWITCH
- ⑭ EJECT SWITCH

DISASSEMBLY PROCEDURE

1. Top cover removal

Loosen the left and right screws ① and ② in Photo 1, and then remove the top cover.

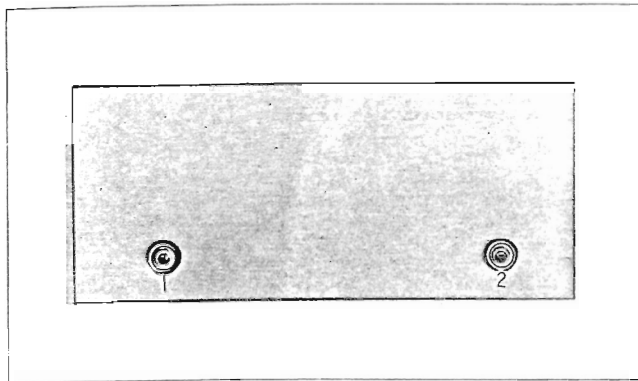

Photo 1

2. Bottom cover removal

Loosen the screws ① to ⑥ in Photo 2, and then remove the bottom cover.

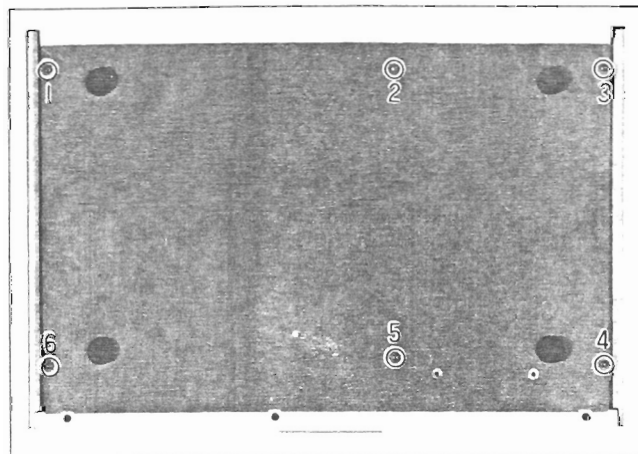

Photo 2

3. Front panel removal

- Remove the top and bottom covers. (Refer to step 1 and 2.)
- Pull out the connectors ① and ② in Photo 3.

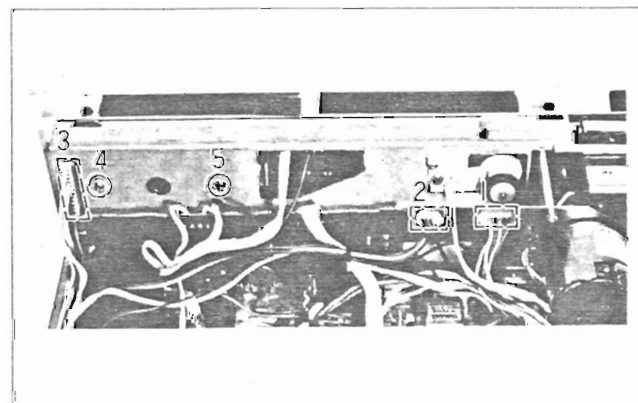

Photo 3

- Remove the knobs (Bias adj., Tape, Rec Balance) ① to ③ in Photo 4. Be careful to remove the Tape knob.
- Loosen the screws ① to ③ in Photo 5 and ① to ③ in Photo 6, and then take out the front panel.

* When attaching the front panel slide the volume knob ⑬ and ⑭ to the right or left and attach the front panel.

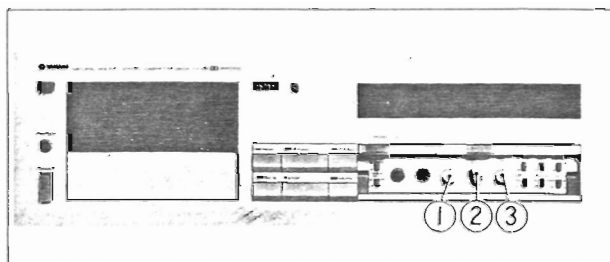

Photo 4

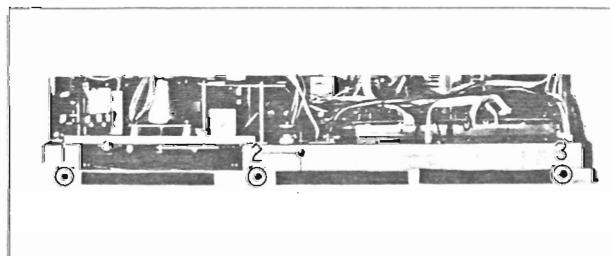

Photo 5

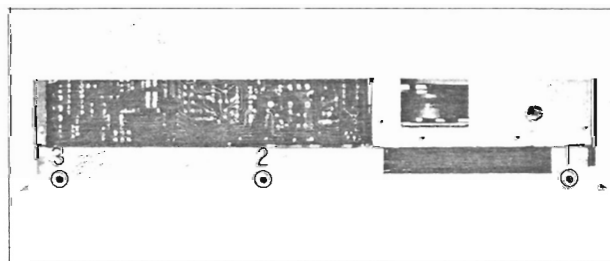

Photo 6

4. The tape mechanism assembly removal

- Remove the front panel. (refer to step 3.)
- Detach the lead wires of the tape mechanism assembly.
- Loosen the screw ① in Photo 7 and remove the rubber belt of the tape counter.
- Pull out the power switch ② in Photo 7.
- Loosen the screws ③ to ⑥ in Photo 7 and remove the tape mechanism assembly, raising it.

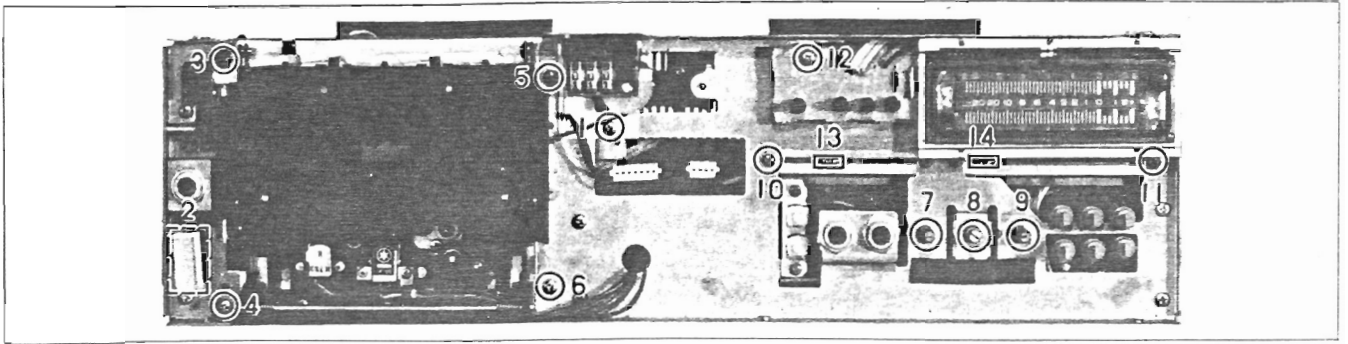

Photo 7

5. Record/Playback printed circuit board removal

- Remove the front panel. (Refer to step 3.)
 - Detach the connectors and lead wires.
 - Remove the nuts ⑦ to ⑨ in Photo 7.
 - Remove the plastic rivets ① and ② in Photo 8 with a driver and loosen the screws ③ to ⑦. Remove the rear panel.
- * It is unnecessary to remove the power cord:
- Loosen the screws ① to ④ in Photo 9 and remove the Record/Playback printed circuit board gently.

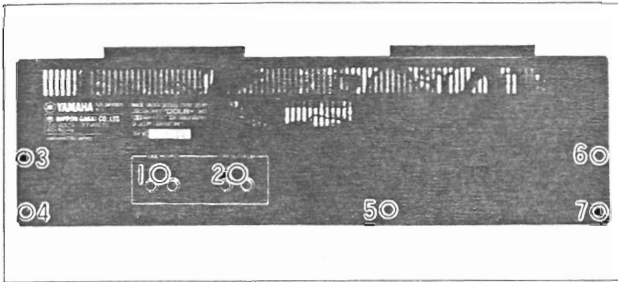

Photo 8

6. The control printed circuit board removal

- Remove the top cover. (Refer to step 1.)
- Detach the connectors and lead wires.
- Push the plastic rivets ① and ② with a driver and remove them. Remove the control printed circuit board.

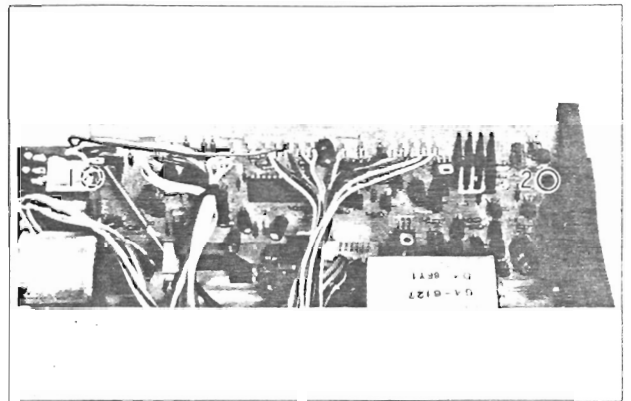

Photo 10

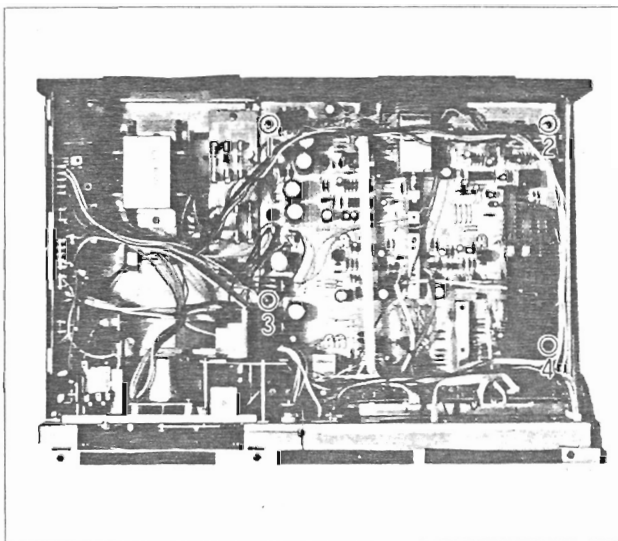

Photo 9

7. Level meter removal

- Remove the front panel. (Refer to step 3.)
- Remove the connector ③ and screws ④ and ⑤, and then remove the level meter.

8. VR printed circuit board removal

- Remove the front panel. (Refer to step 3.)
- Detach the lead wires.
- Loosen the screws ⑩ and ⑪ and remove the VR printed circuit board.

9. LED printed circuit board removal

- Remove the front panel. (Refer to step 3.)
- Detach the lead wires.
- Loosen the screw ⑫ in Photo 7 and remove the LED printed circuit board.

ADJUSTMENTS

1. Tape speed adjustment

- 1) Connect as shown in Fig. 1.
 - 2) Play back the MTT-111 (3kHz) test tape, rotate the capstan motor semi-fixed resistor, and adjust so that the frequency counter displays indicates $3000 \pm 1 \frac{1}{2}$ Hz.
- * Don't push the volume with a driver.

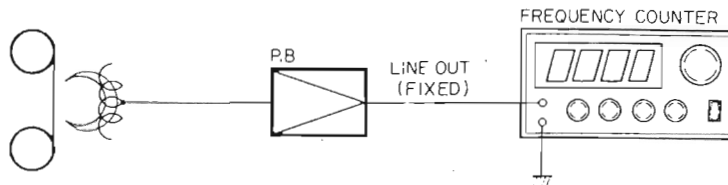
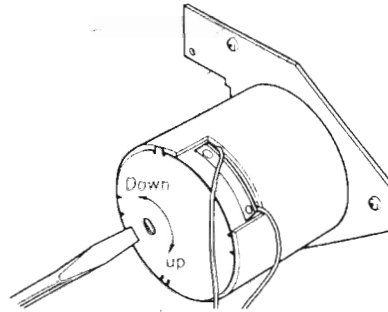

Fig 1

2. Playback level adjustment

- 1) Connect as shown in Fig. 2.
- 2) Set the tape selector switch to 'LH'.
- 3) Play back the MTT-112 (333Hz) test tape, rotate the VR101 (left channel) and VR102 (right channel) on the record/playback printed circuit board, and adjust so that the VTVM display indicates -3dBm (about 550mV).

3. Playback frequency response adjustment

- 1) Connect as shown in Fig. 2.
 - 2) Set the selector switch to 'LH'.
- Play back the MTT-116U test tape and measure the levels with the VTVM, and adjust the playback frequency response so that the measured values are within the specified range in Fig. 3.

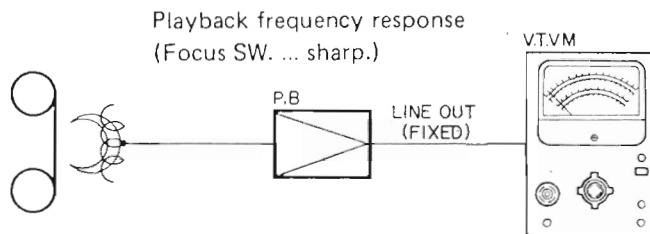

Fig 2

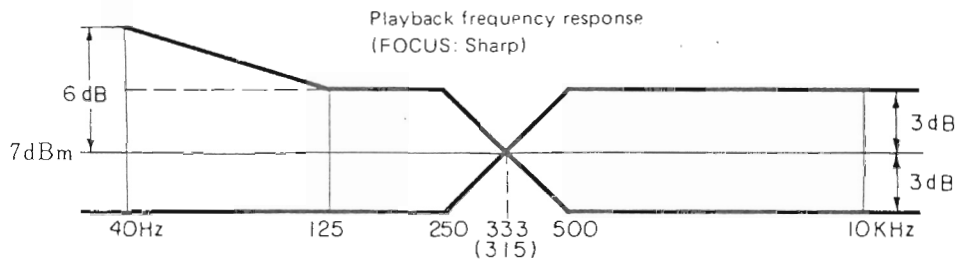
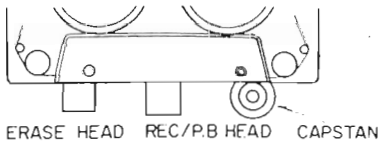
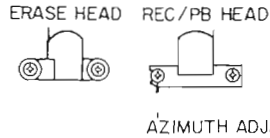

Fig 3

4. Head azimuth adjustment

- 1) Connect as shown in Fig. 2.
Play back the MTT-114, rotate the azimuth adjust screw and adjust so that the VTVM pointer deflection is brought to its maximum. After the adjustment, Lock the screw.



5. Peak level meter adjustment

- 1) Connect as shown in Fig. 4.
- 2) Set the cassette deck to the recording mode and rotate the Rec Level and Rec Balance VR.
- 3) Adjust for a +1dBm value at the Line Out terminals when a 1kHz -10dBm signal is applied from the audio frequency oscillator. Adjust semi-fixed resistor VR401 (left channel) and VR402 (right channel) on the recording/playback printed circuit board so that the 0 dB display of the level meter lights perfectly.

6. Recording level adjustment

- 1) Connect as shown in Fig. 4.
- 2) Load a CrO₂ tape into the cassette deck, set the deck to the recording mode, and set the tape selector switch to 'CrO₂'.
- 3) Adjust the Rec Level and Rec Balance volume on the front panel to produce a -7dBm output at the Line Out terminals when a 333Hz -10 dBm signal is applied from the audio frequency oscillator and record this tape and playback.
- 4) Adjust the semi-fixed resistors VR301 (left channel) and VR302 (right channel) on the recording/playback printed circuit board so that the level is -7 ± 1.5 dBm during recording and play back.

7. Recording Bias adjustment

- 1) Connect as shown in Fig. 4.
- 2) Set the deck to the recording mode and adjust the Rec Level and Rec Balance volume to produce a -27dBm output at the Line out terminals when a 333Hz signal is applied from the audio frequency oscillator. Now adjust the recording bias.
- 3) Set BIAS ADJ VR to the center position.

* CrO₂ tape (TDK SA C-60 or equivalent) recording bias adjustment.

Set the cassette deck to the recording mode, and set the tape selector switch to 'CrO₂'. Apply 1kHz and 10kHz signals from the audio frequency oscillator. Measure the level of each signal when that signal is recorded for about 10 seconds and played back. Adjust VR303 (left channel) and VR304 (right channel) on the recording/playback printed circuit board so that the 10 kHz output level compared with 1 kHz output becomes ± 3 dB.

* LH tape (Maxell UD C-60 or equivalent) recording bias adjustment

- ① Set the cassette deck to the recording mode and set the tape selector switch to 'LH' (low noise, high output).
- ② Apply 1kHz and 10 kHz signals from the audio frequency oscillator. Measure the level of each signal when that signal is recorded for about 10 seconds and played back. Adjust VR305 on the recording/playback printed circuit board so that the 10kHz output level compared with 1kHz output becomes ± 3 dB.

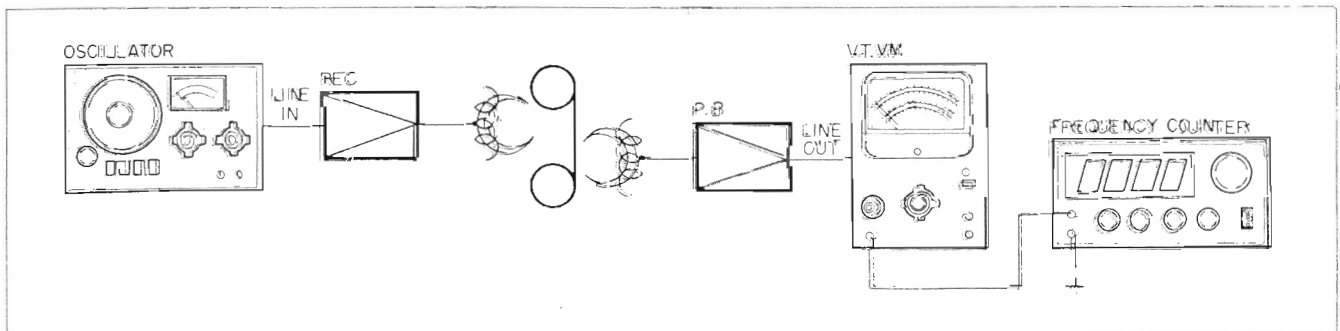

Fig. 4

SPECIFICATIONS

Type	4-track, 2-channel cassette deck
● Cassette mechanism	
Tape speed	4.8 cm/set \pm 1%
Wow/Flutter	Less than 0.03% (wrms)
Fast forward/rewind time	75 sec. (with C-60 tape)
● Amplifier section	
Recording/playback frequency response	30 to 16,000Hz \pm 3dB (LH tape) , 30 to 18,000Hz \pm 3dB (CrO ₂ tape)
Total distortion	Less than 1% (LH tape, 1kHz, 160 nwb/m) Less than 1.6% (CrO ₂ tape, 1kHz, 160 nwb/m)
Total signal-to-noise ratio	Better than 60dB (CrO ₂ tape, NR OFF) Better than 52dB (CrO ₂ tape, DIN, 333Hz, 3% distortion, NR OFF)
Dolby effect	Better than 9dB
Channel separation	More than 30dB (1kHz)
Bias frequency	105kHz
Erasure rate	More than 60dB (400Hz)
Input sensitivity/impedance	MIC: 0.3mV/5K Ω , LINE: 60mV/50K Ω
Output level/impedance	LINE: 340mV (reference level, playback volume at MAX) PHONES: 1mW/8 Ω (160nwb/m), 4mW/150 Ω (160 nwb/m)
● General	
Semiconductors used	FETs x (2), transistors x (67), ICs x (9), diodes x (45)
Power Supplies	U.S.A. & Canadian models 120V, AC 60Hz European model 110 ~ 130V/220 ~ 240V, AC 50Hz North European model 220V, AC 50Hz General model 110 ~ 130V/220 ~ 240V, AC 50/60Hz British & Australian models 240V, AC 50Hz
Power Consumption	27W
Dimensions (W x H x D)	435 x 140 x 286 mm (17-1/8" x 5-1/2" x 11-1/4")
Weight	9 kg (19 lbs 13 oz)

(Specifications and design are subject to change without notice since policy of this company is one of continuous improvement.)

BLOCK DIAGRAM

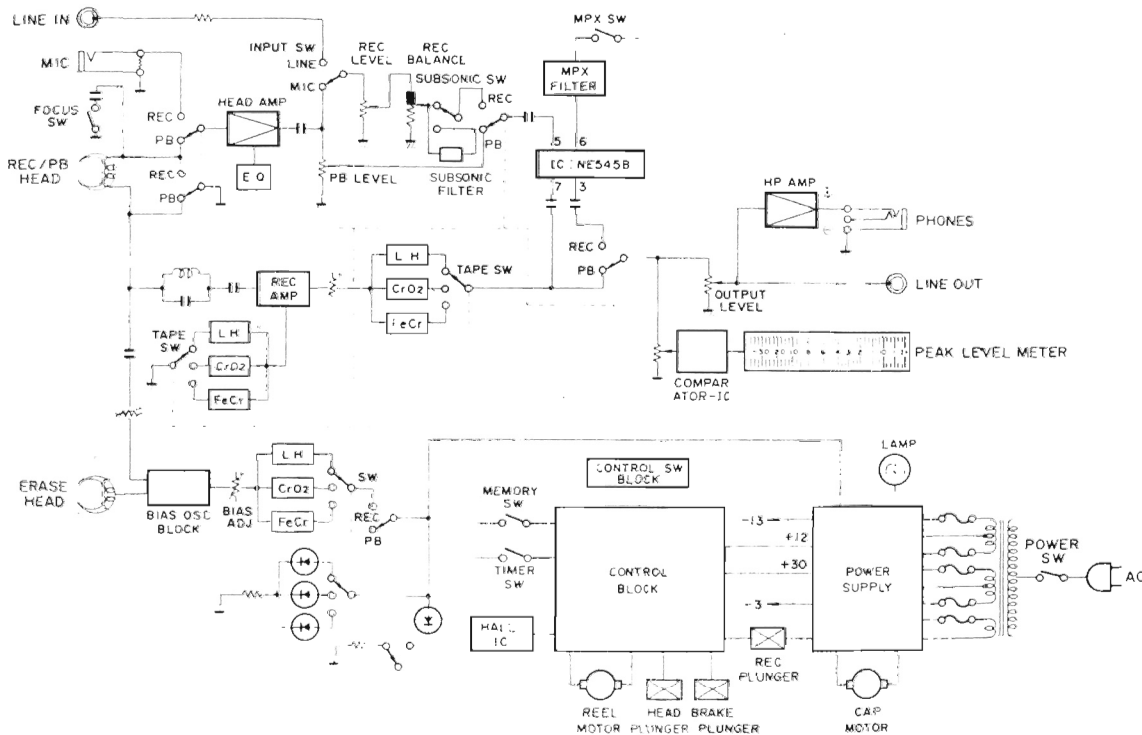

CONTROL C. BOARD

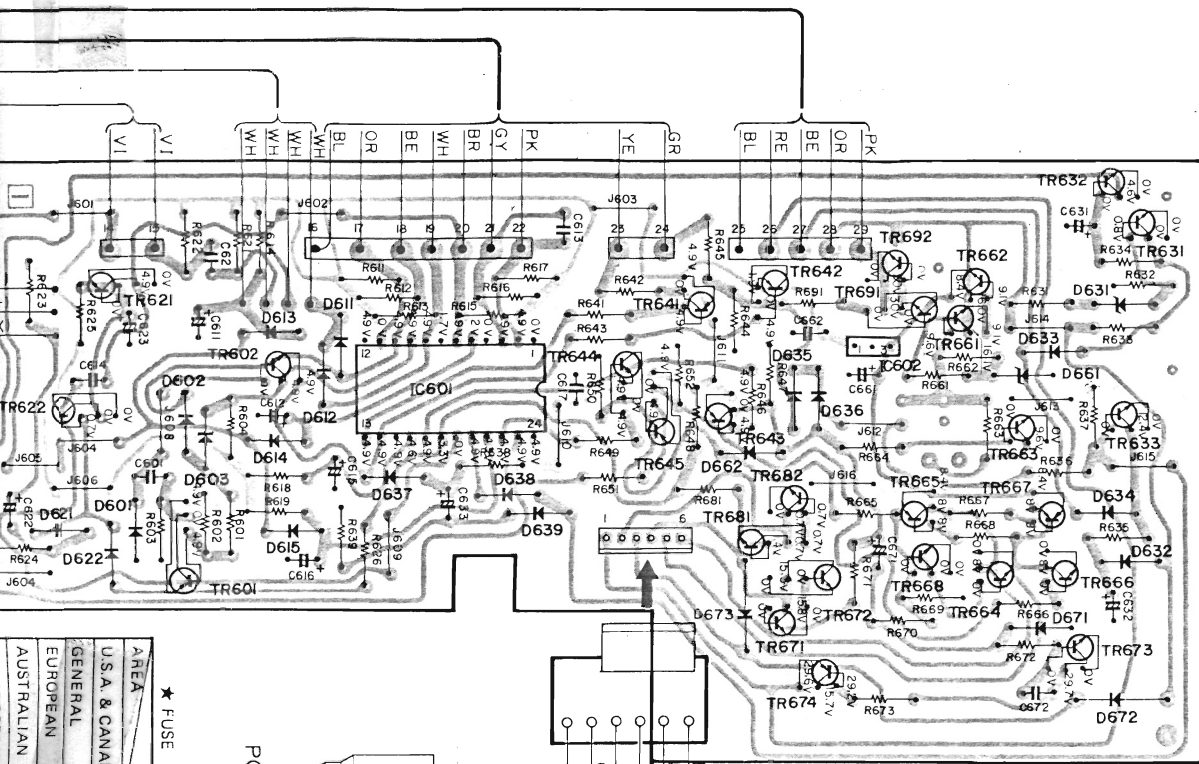

GENERAL, EUROPEAN MODELS

VOLTAGE SELECTOR

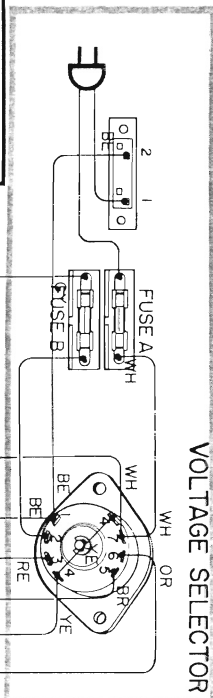

US, CANADIAN MODELS

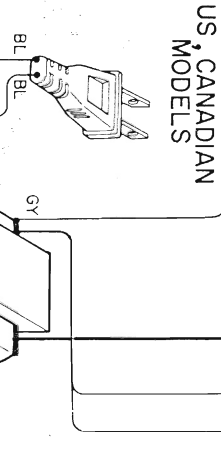

POWER TRANSFORMER

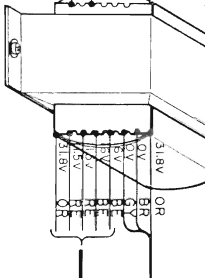

POWER SW

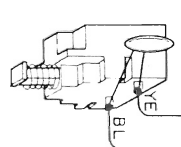

★ FUSE

AREA	F101	F102	F103	F104	F105
U.S.A. & CANADIAN	1A 250V	1A 250V	0.75A 250V	0.75A 250V	0.75A 250V
GENERAL			1A 250V	1A 250V	1A 250V
EUROPEAN			1A 250V	1A 250V	1A 250V
AUSTRALIAN	1A 250V	1A 250V	1A 250V	1A 250V	1A 250V

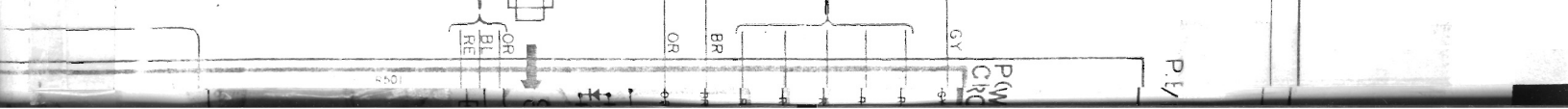
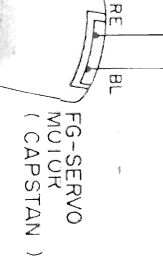
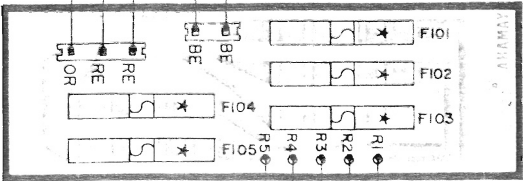

- WIRE COLOR ABBREVIATIONS
- BL ▶ Black
 - BR ▶ Brown
 - RE ▶ Red
 - OR ▶ Orange
 - YE ▶ Yellow
 - GR ▶ Green
 - BE ▶ Blue
 - VI ▶ Violet
 - GY ▶ Gray
 - WH ▶ White
 - GG ▶ Grass Green
 - SB ▶ Sky Blue
 - PK ▶ Pink

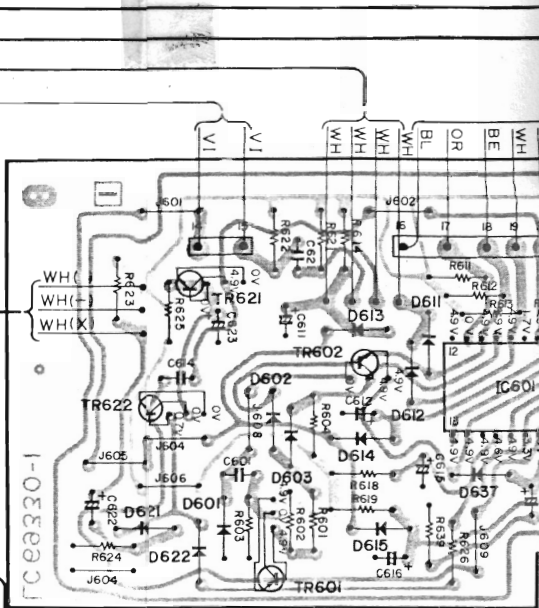
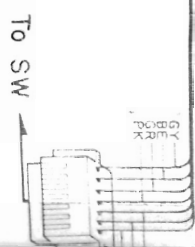
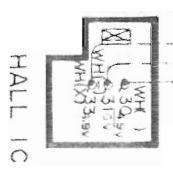
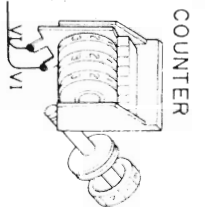
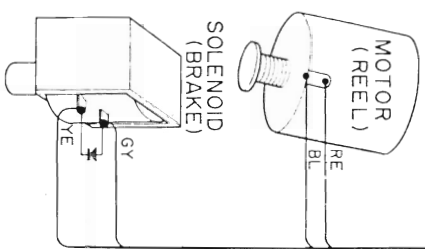
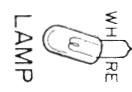
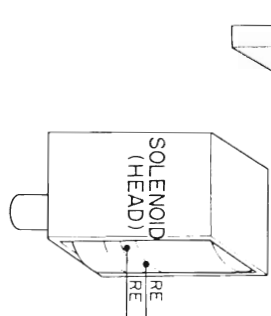
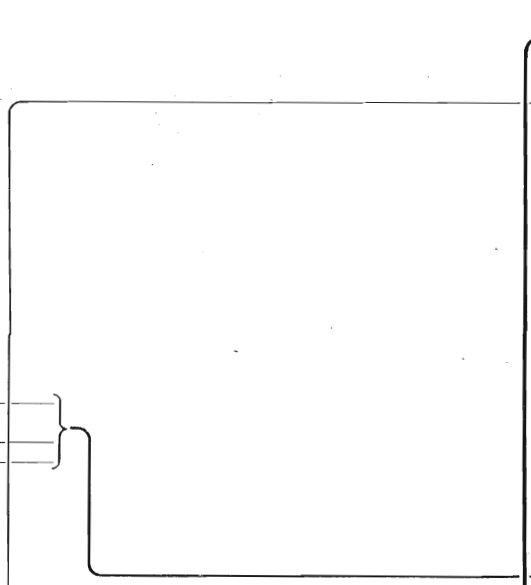
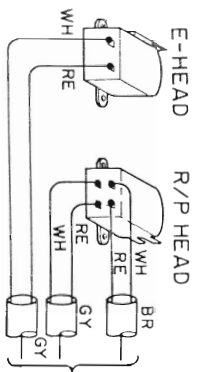
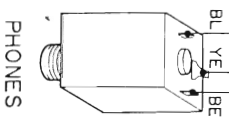

★ FUSE

AREA	F101	F102	F103	F104	F105
U.S.A. & CANADIAN	1A 250V	1A 250V	0.75A 250V	0.75A 250V	0.75A 250V
GENERAL			1A 250V	1A 250V	1A 250V
EUROPEAN			1A 250V	1A 250V	1A 250V
AUSTRALIAN	1A 250V	1A 250V	1A 250V	1A 250V	1A 250V
N. EUROPEAN	315 mA	315 mA	630 mA	630 mA	630 mA
BRITISH	315 mA	315 mA	630 mA	630 mA	630 mA

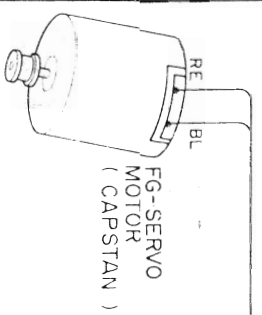
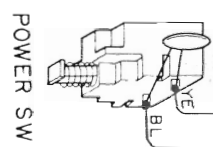

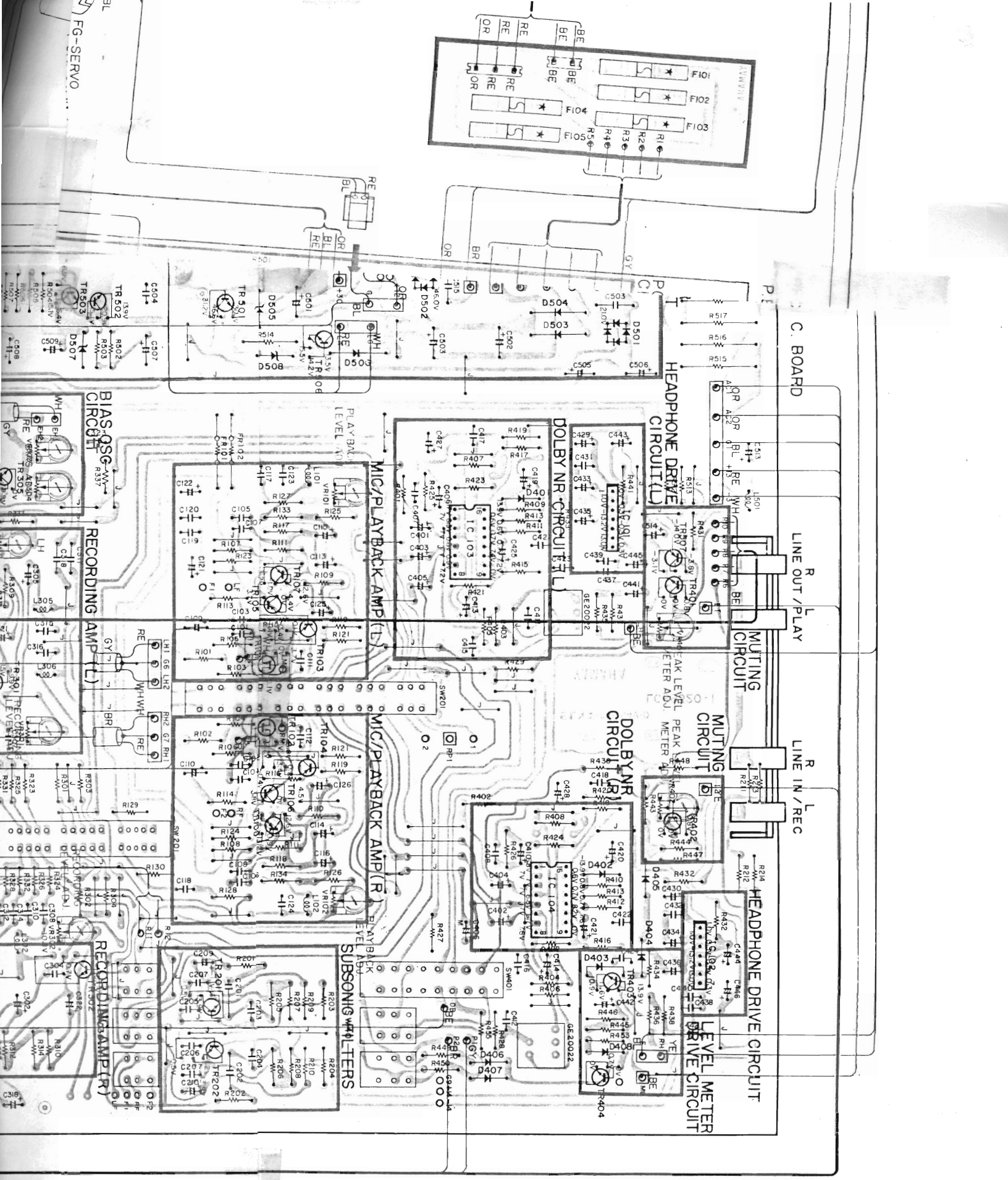

SIGNAL PATH

- +14V
- - - -14V
- GROUND
- Lch REC/PB
- Rch PB

GENERAL, EUROPEAN MODELS

VOLTAGE SELECTOR

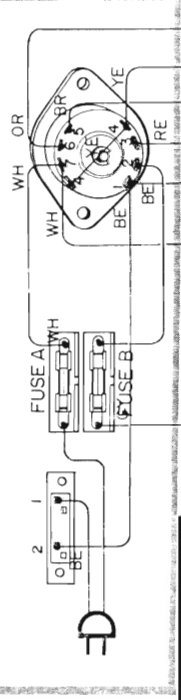

CONTROL C. BOARD

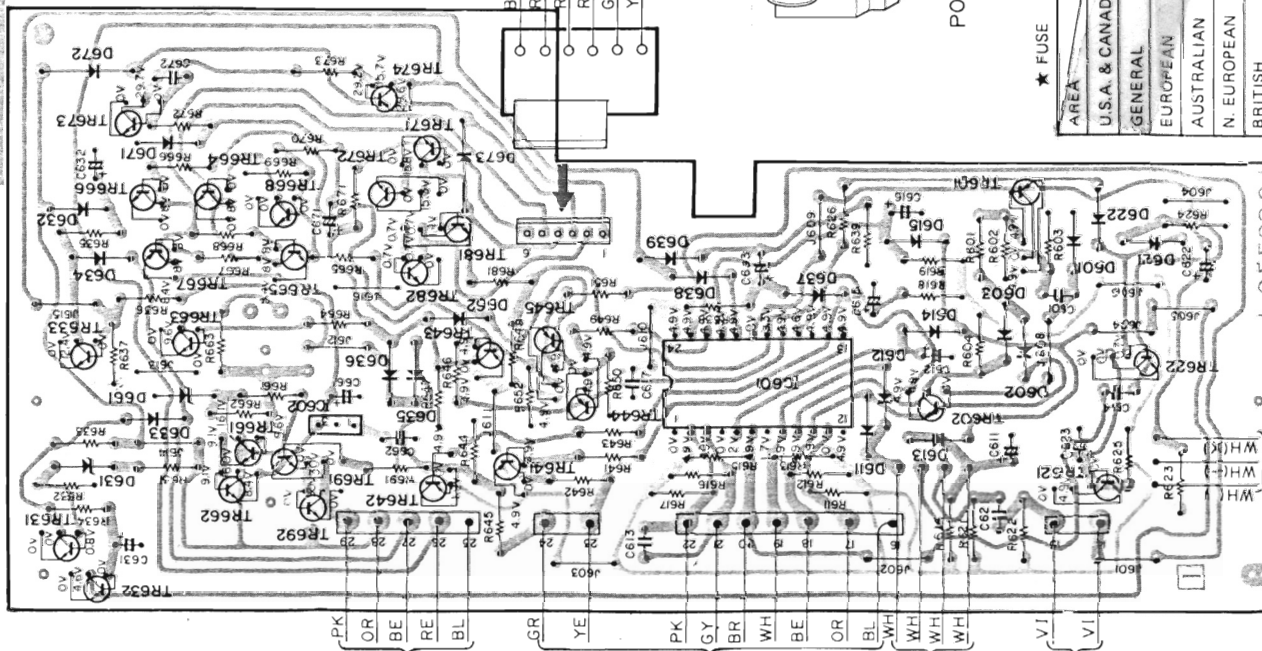

US, CANADIAN MODELS

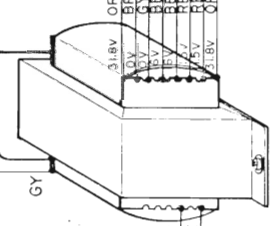

POWER TRANSFORMER



POWER SW

★ FUSE

AREA	F101	F102	F103	F104	F105
U.S.A. & CANADIAN	1A 250V	1A 250V	0.75A 250V	0.75A 250V	0.75A 250V
GENERAL			1A 250V	1A 250V	1A 250V
EUROPEAN			1A 250V	1A 250V	1A 250V
AUSTRALIAN	1A 250V	1A 250V	1A 250V	1A 250V	1A 250V
N. EUROPEAN	315 mA	315 mA	630 mA	630 mA	630 mA
BRITISH	315 mA	315 mA	630 mA	630 mA	630 mA

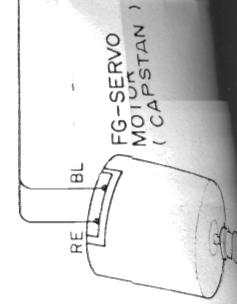

FG-SERVO MOTOR (CAPSTAN)

SCHEMATIC DIAGRAM

A B C D

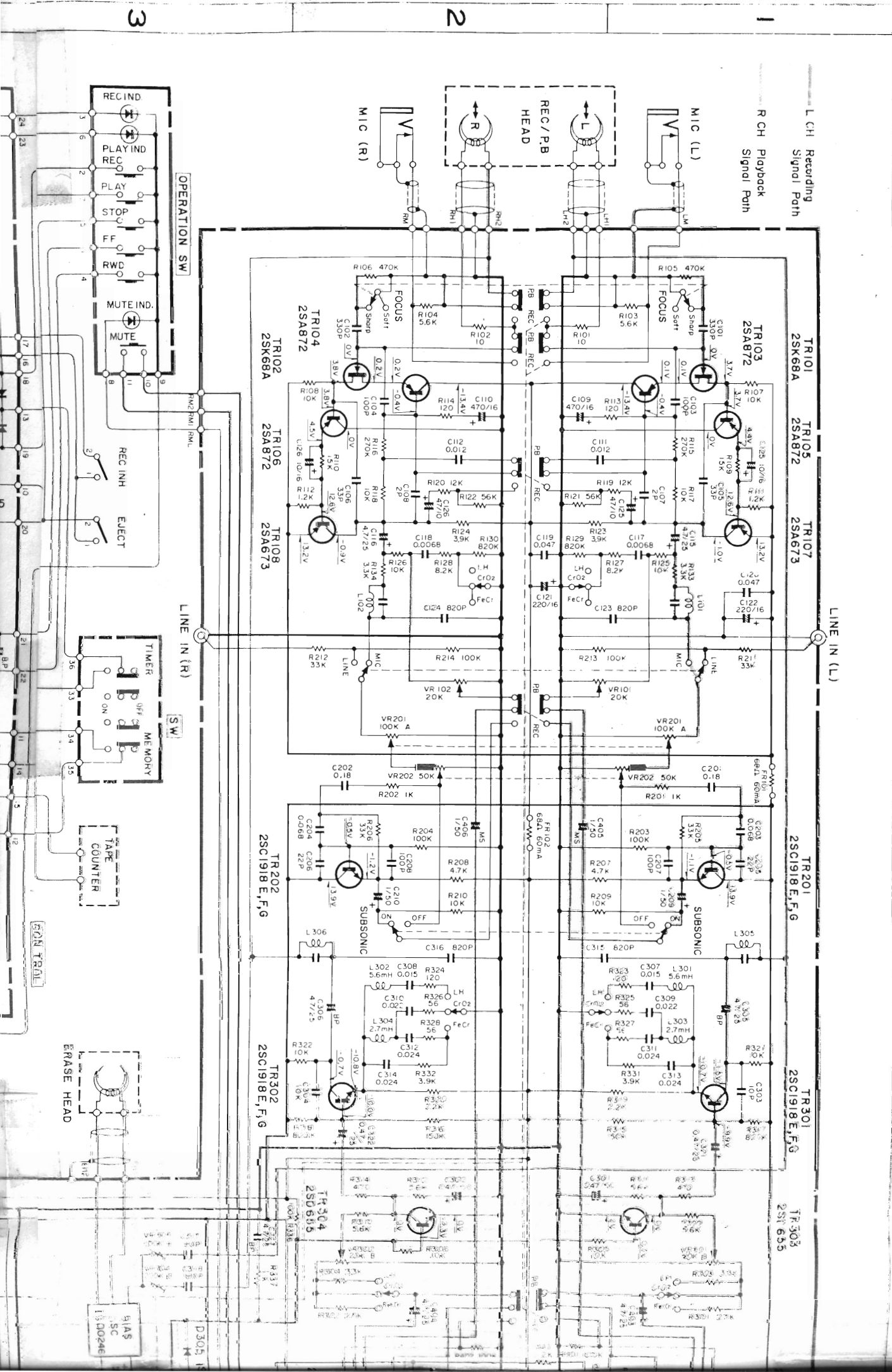

3

2

1

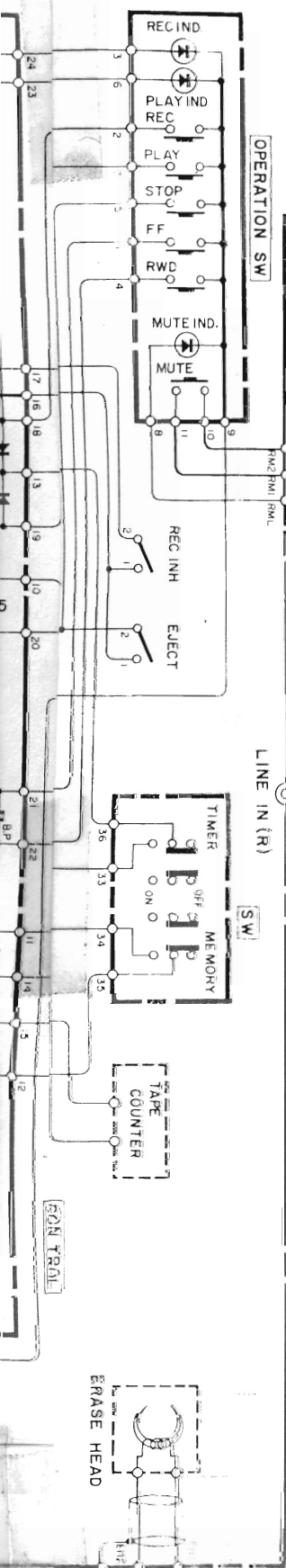

51AS
5SC
15D0246

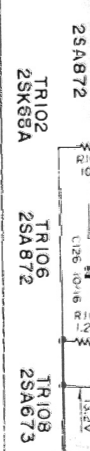
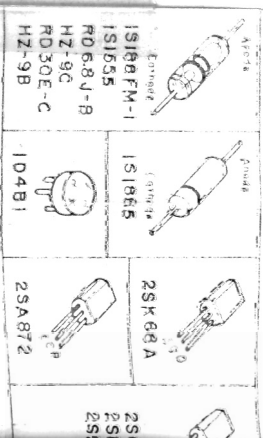
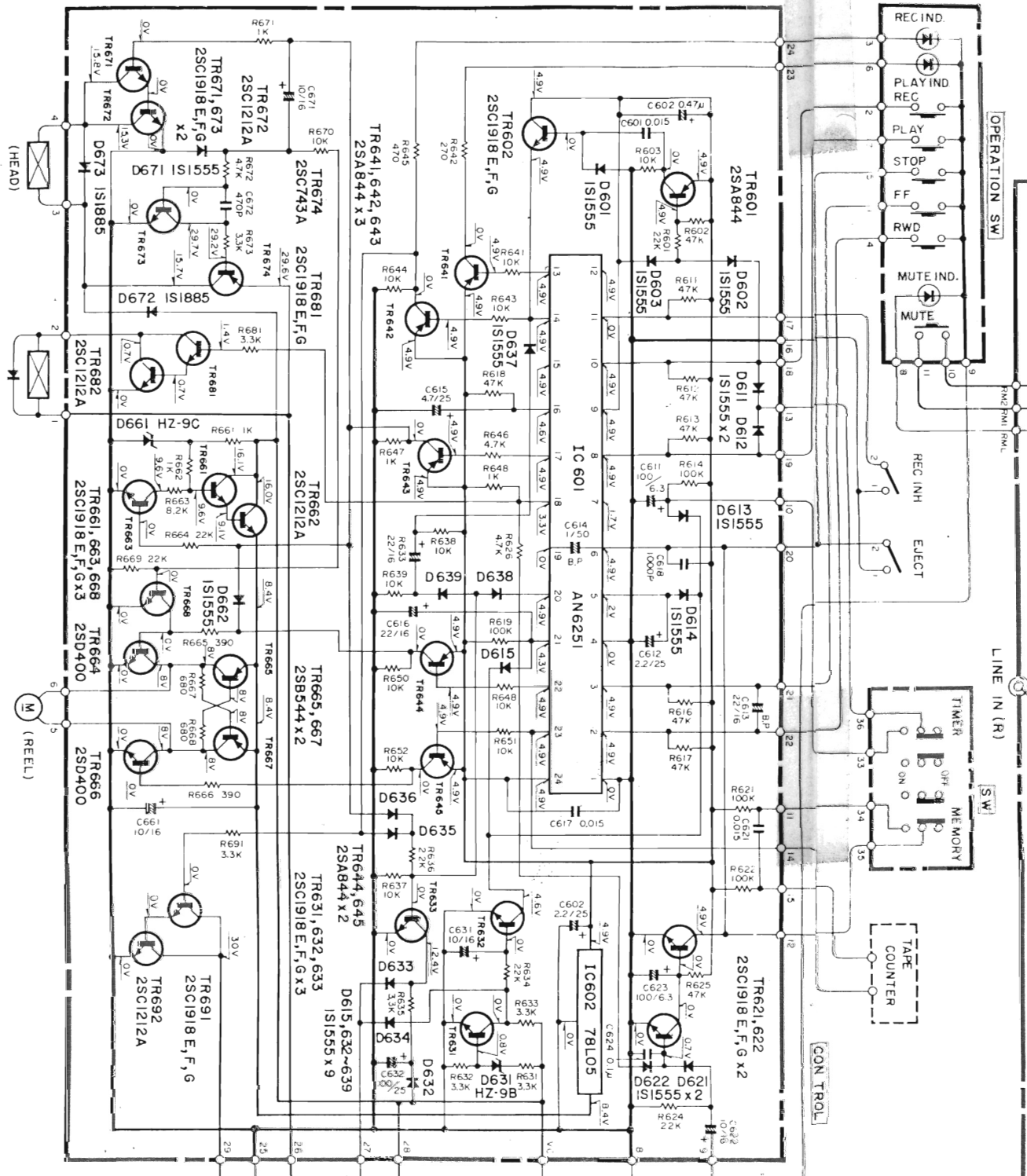

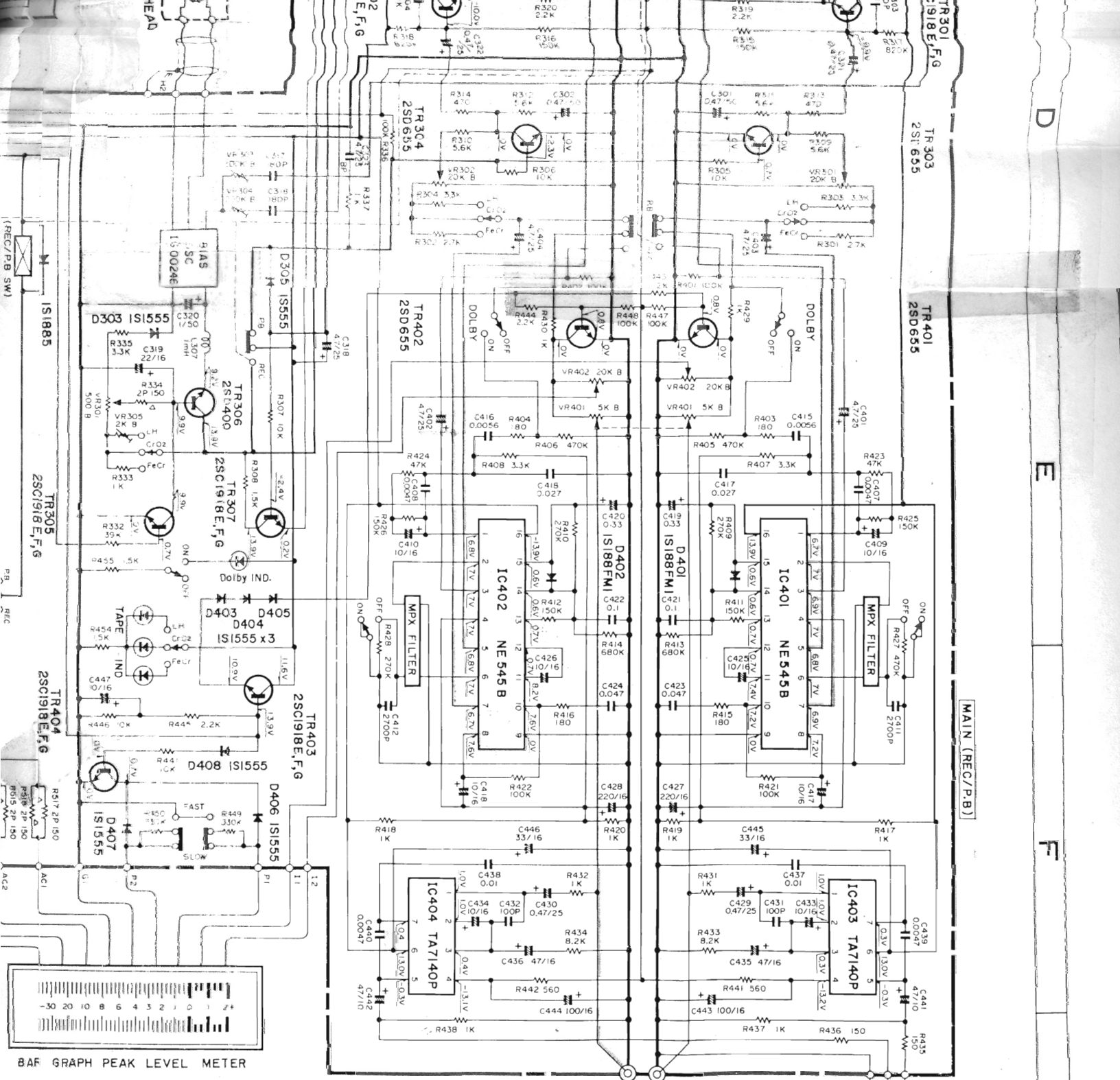

BAF GRAPH PEAK LEVEL METER

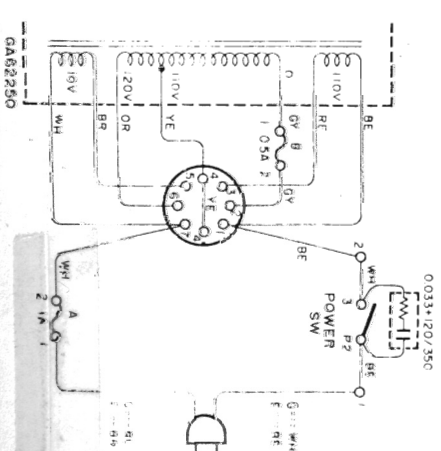

GENERAL B EUROPEAN MODELS

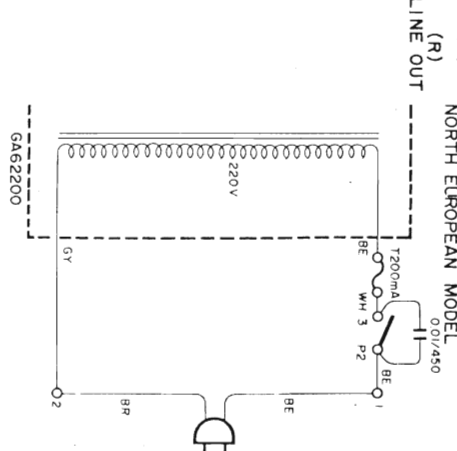

AUSTRALIAN & BRITISH MODELS

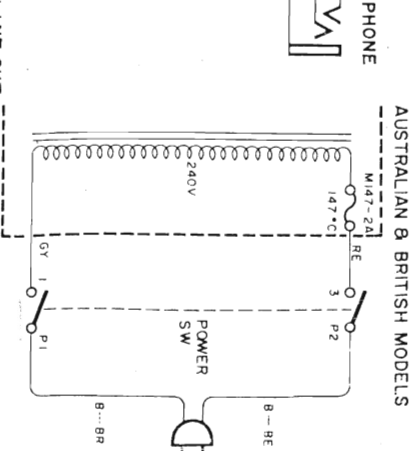

NORTH EUROPEAN MODEL



LINE OUT (R)



LINE OUT (L)



PHONE

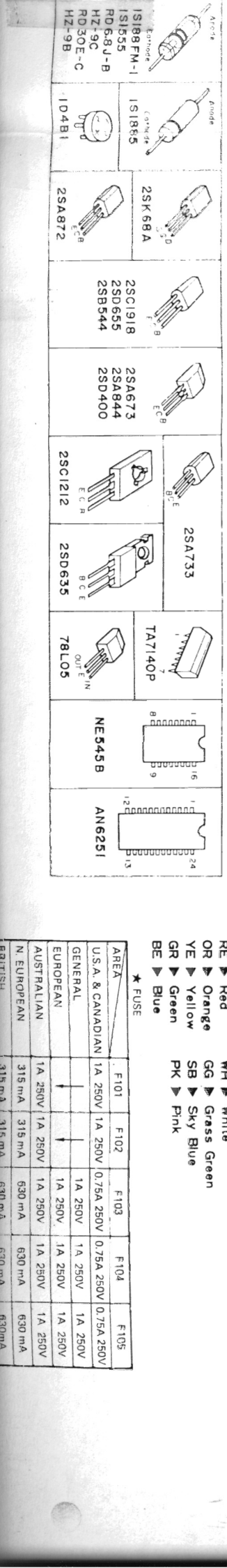
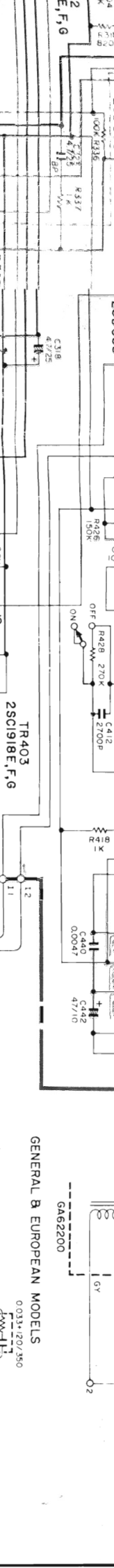
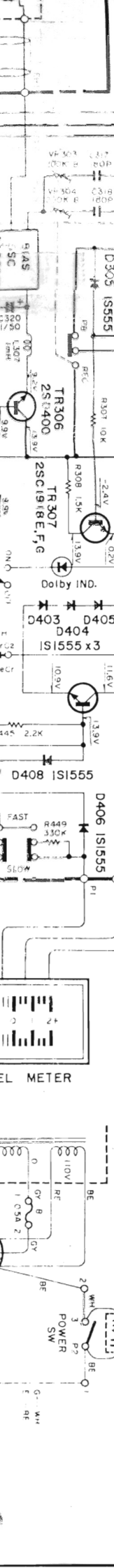
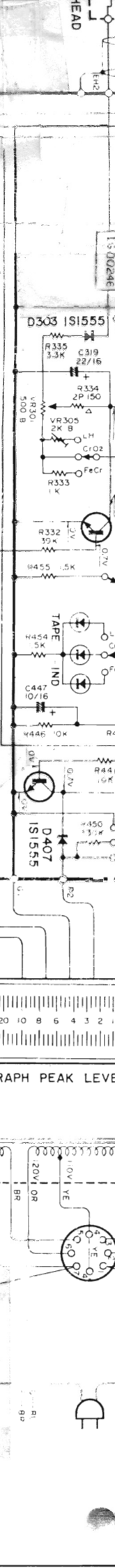
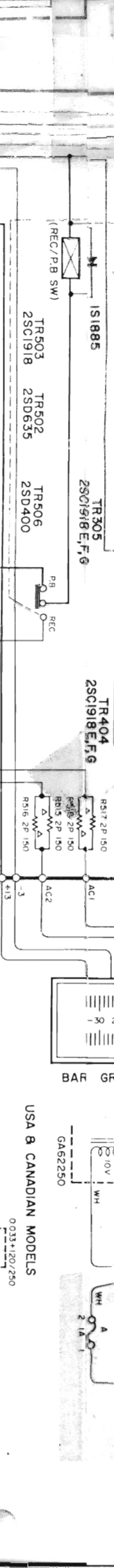
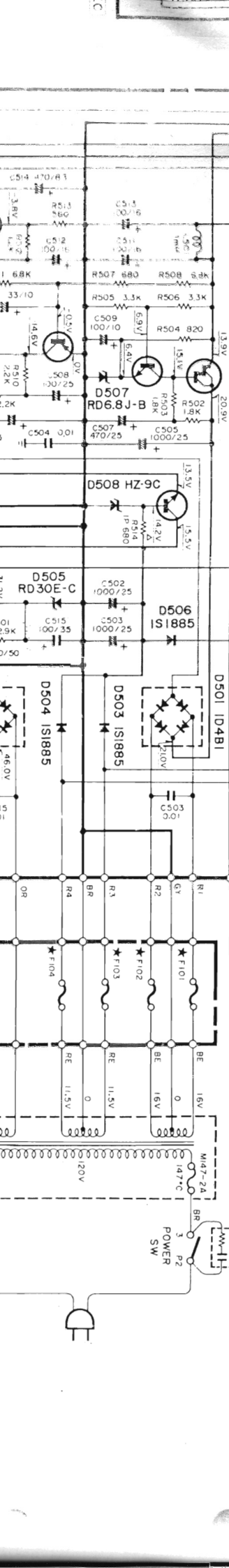
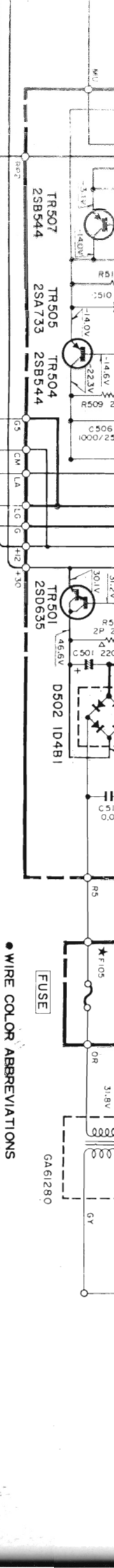
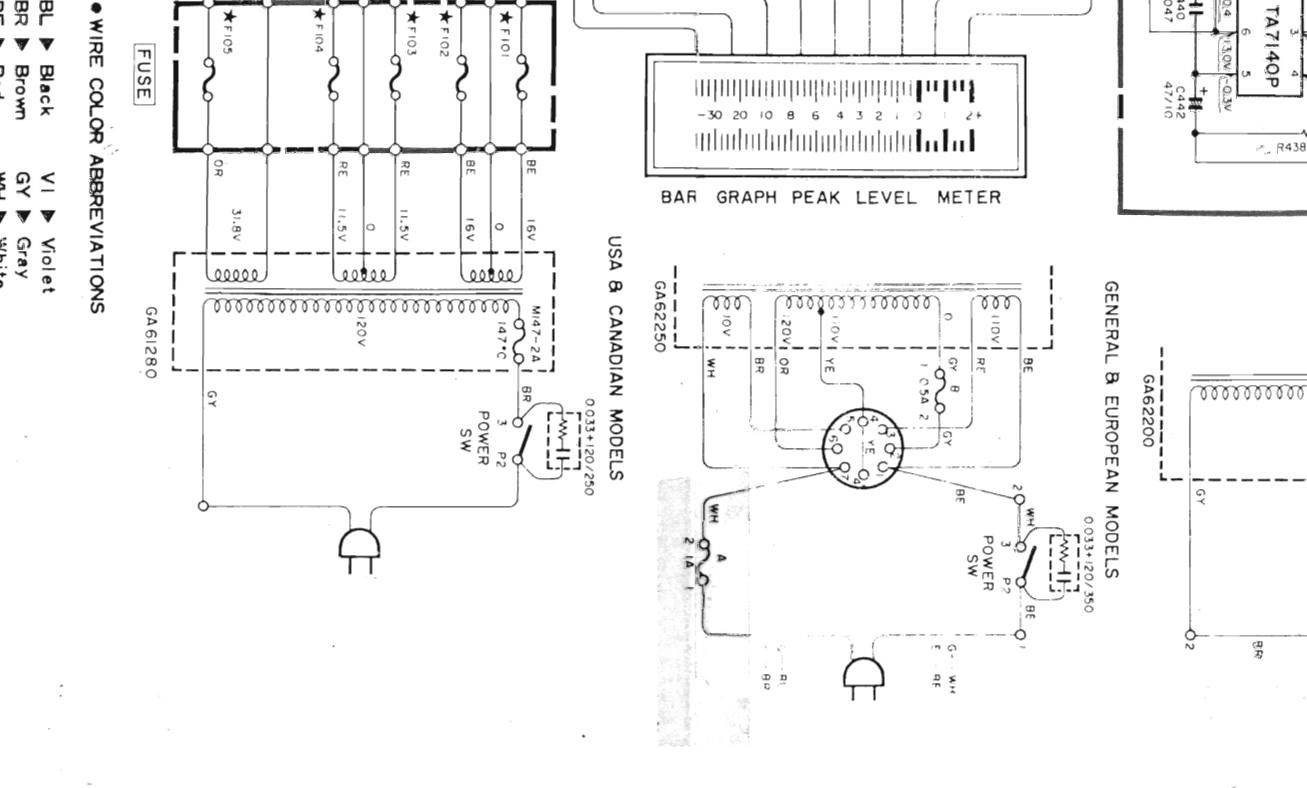
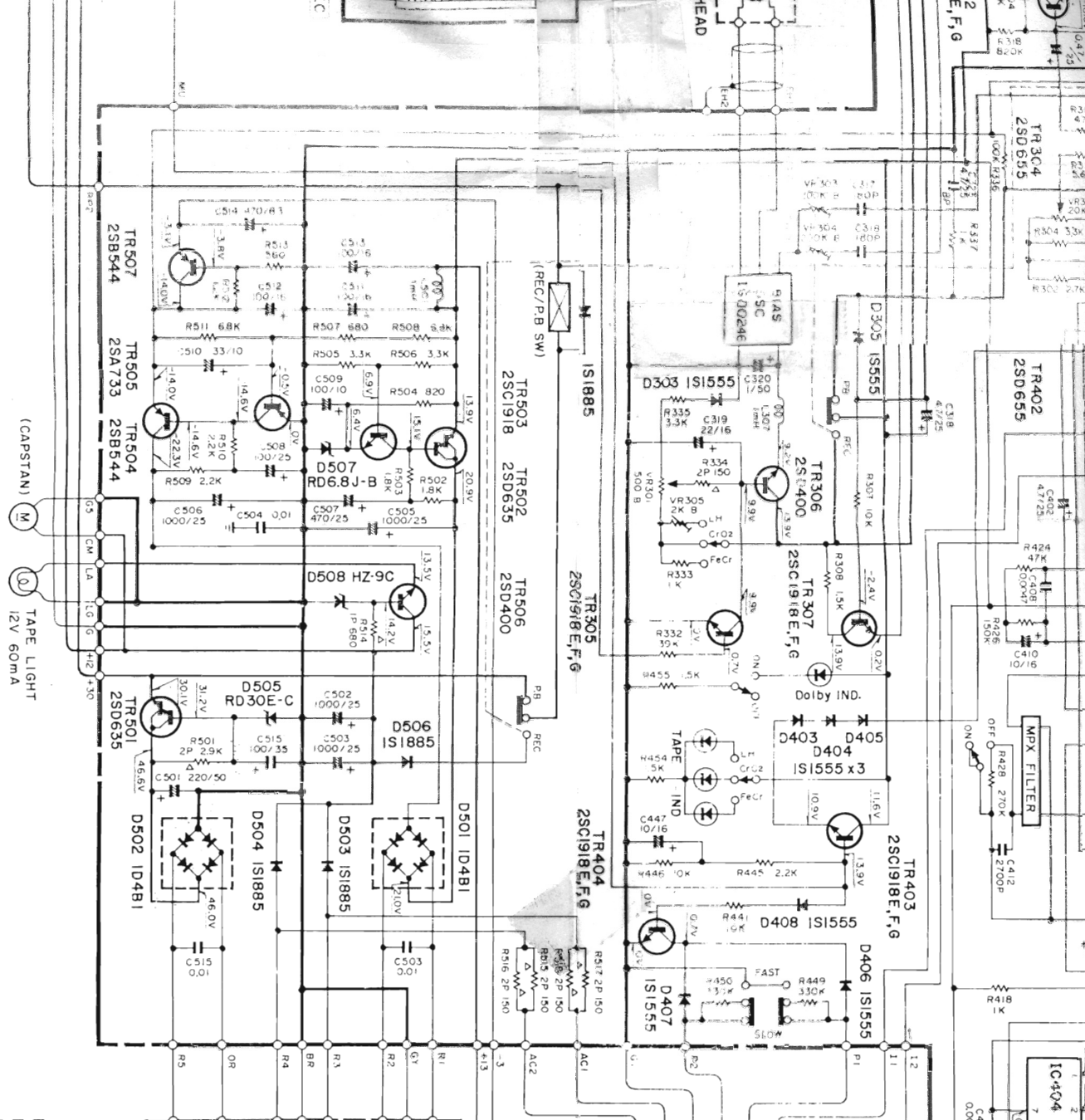

● WIRE COLOR ABBREVIATIONS

BL ▶ Black	VI ▶ Violet
BR ▶ Brown	GY ▶ Gray
RE ▶ Red	WH ▶ White
OR ▶ Orange	GG ▶ Grass Green
YE ▶ Yellow	SB ▶ Sky Blue
GR ▶ Green	PK ▶ Pink
BE ▶ Blue	

★ FUSE

AREA	F101	F102	F103	F104	F105
U.S.A. & CANADIAN	1A 250V	1A 250V	0.75A 250V	0.75A 250V	0.75A 250V
GENERAL			1A 250V	1A 250V	1A 250V
EUROPEAN			1A 250V	1A 250V	1A 250V
AUSTRALIAN	1A 250V	1A 250V			
N. EUROPEAN	315 mA	315 mA	630 mA	630 mA	630 mA
BRITISH	315 mA	315 mA	630 mA	630 mA	630 mA